

EFU B80x73

Utåtgående enkelbåge

Tröskelvarianter enl. ritning S50-101-20

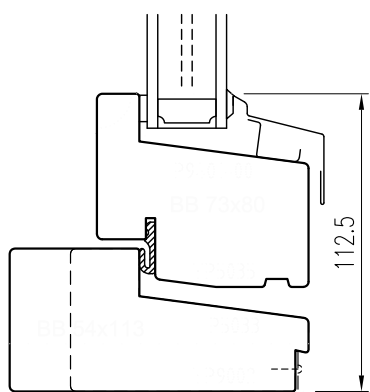
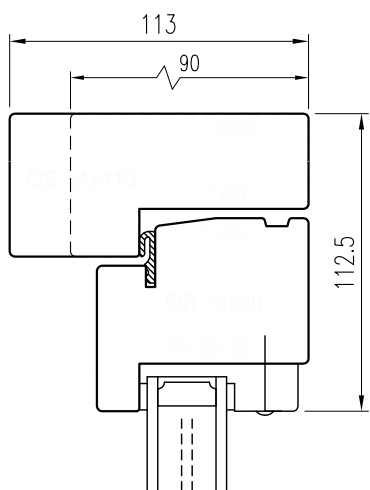

Vertikalsnitt EFU Öp

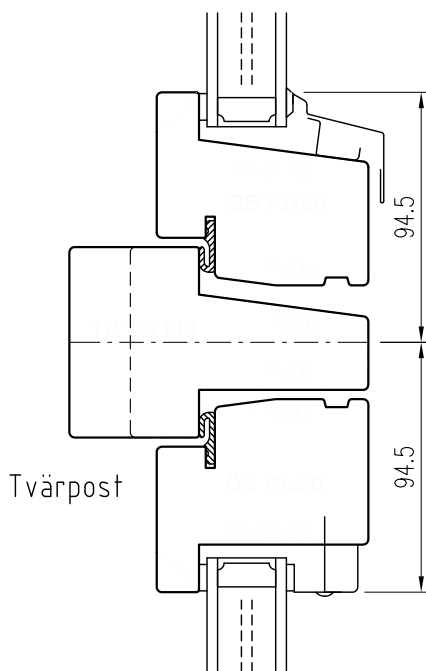

Tvärpost

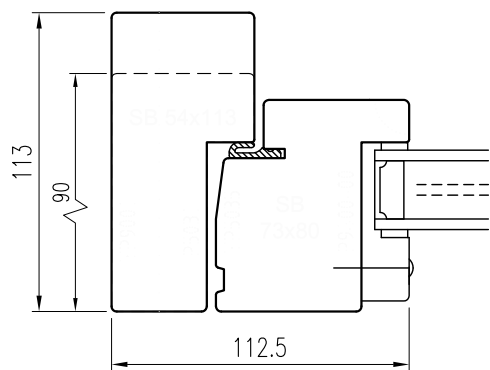
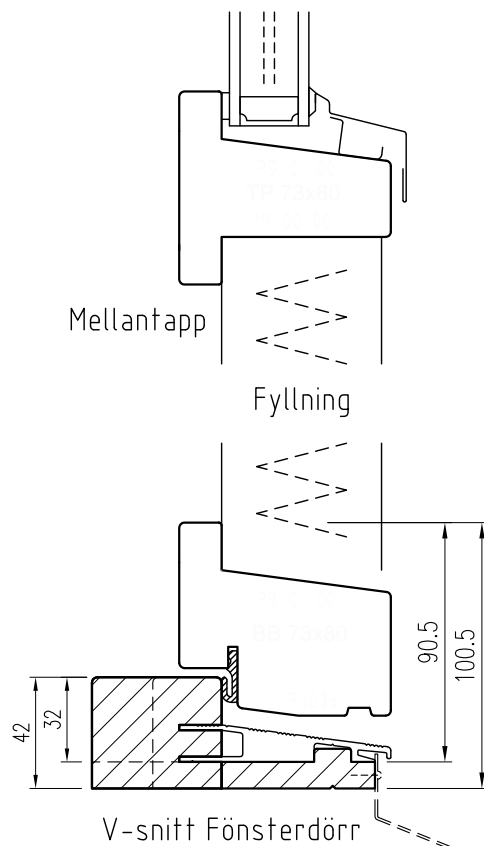

Horizontalsnitt

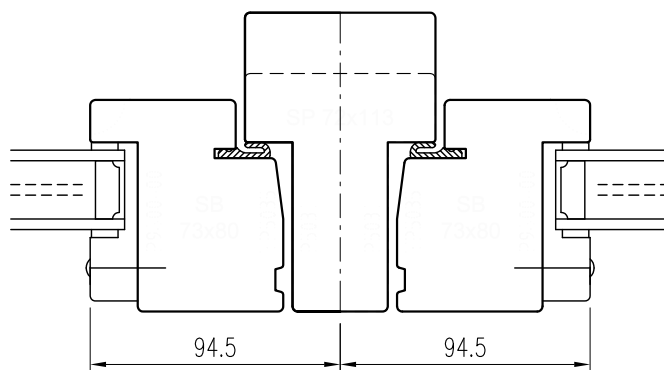

Post

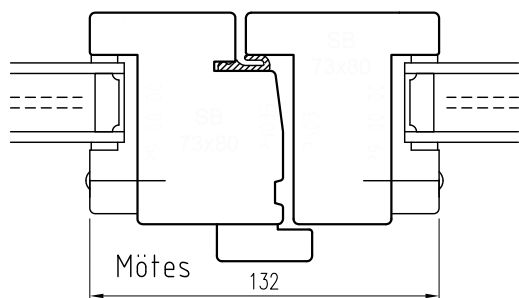

Mötes

Tel. 0914/29100 www.wbtra.se mail@wbtra.se		wb trä	
Skala A4 1:3	Beskrivning Detaljsnitt		
Datum 2016-05-30	Ritad HE	Ritningsnamn/Filnamn S50-101-01	Rev. -