

KFU B45x64

Ut\u00e4tg\u00e5ende kopplad b\u00e5ge

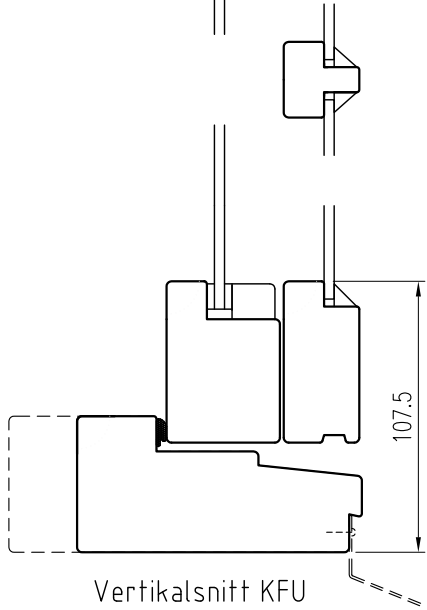

Vertikalsnitt KFU

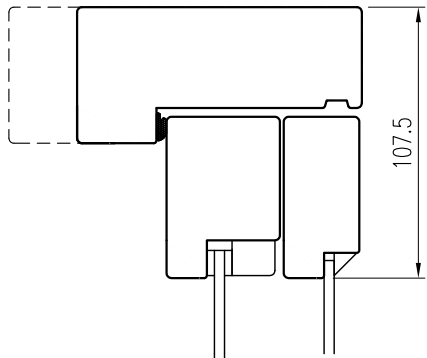
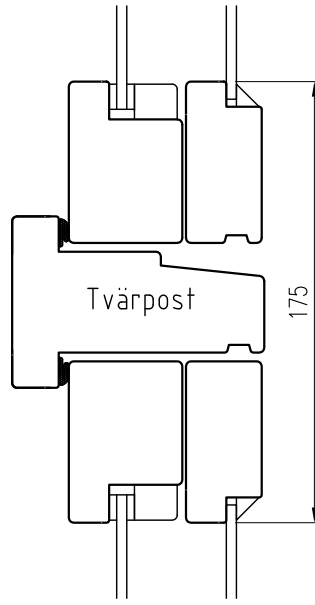

Tvrpost

Mellantapp

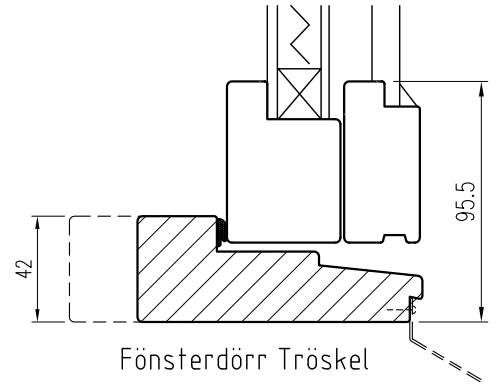
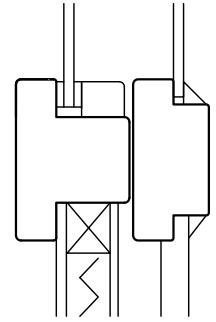

F\u00f6nsterd\u00f6rr Tr\u00f6skel

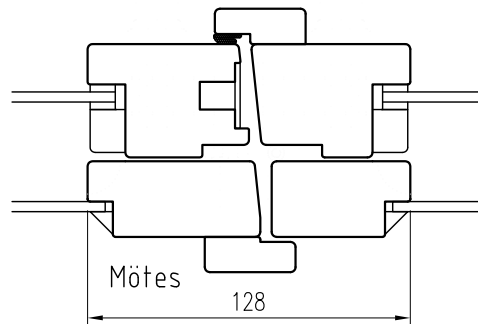

M\u00f6tes

128

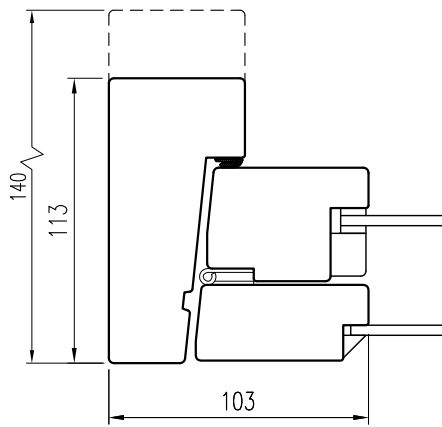

Horizontalsnitt KFU

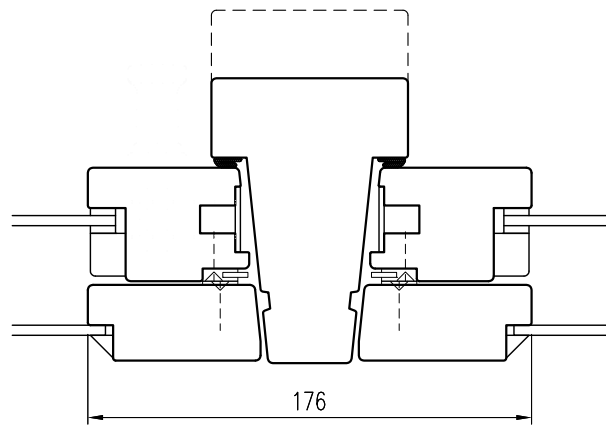

Post

Tel. 0914/29100
www.wbtra.se
mail@wbtra.se



Skala
A4 1:3

Beskrivning
Detaljsnitt

Datum
2017-06-29

Ritad
HE

Ritningsnamn/Filnamn
S51-211-01

Rev.
A